



Fraunhofer

ICT

FRAUNHOFER INSTITUTE FOR CHEMICAL TECHNOLOGY ICT

FUEL CELLS AND WATER ELECTROLYSIS FROM THE MATERIAL TO THE FINISHED PRODUCT

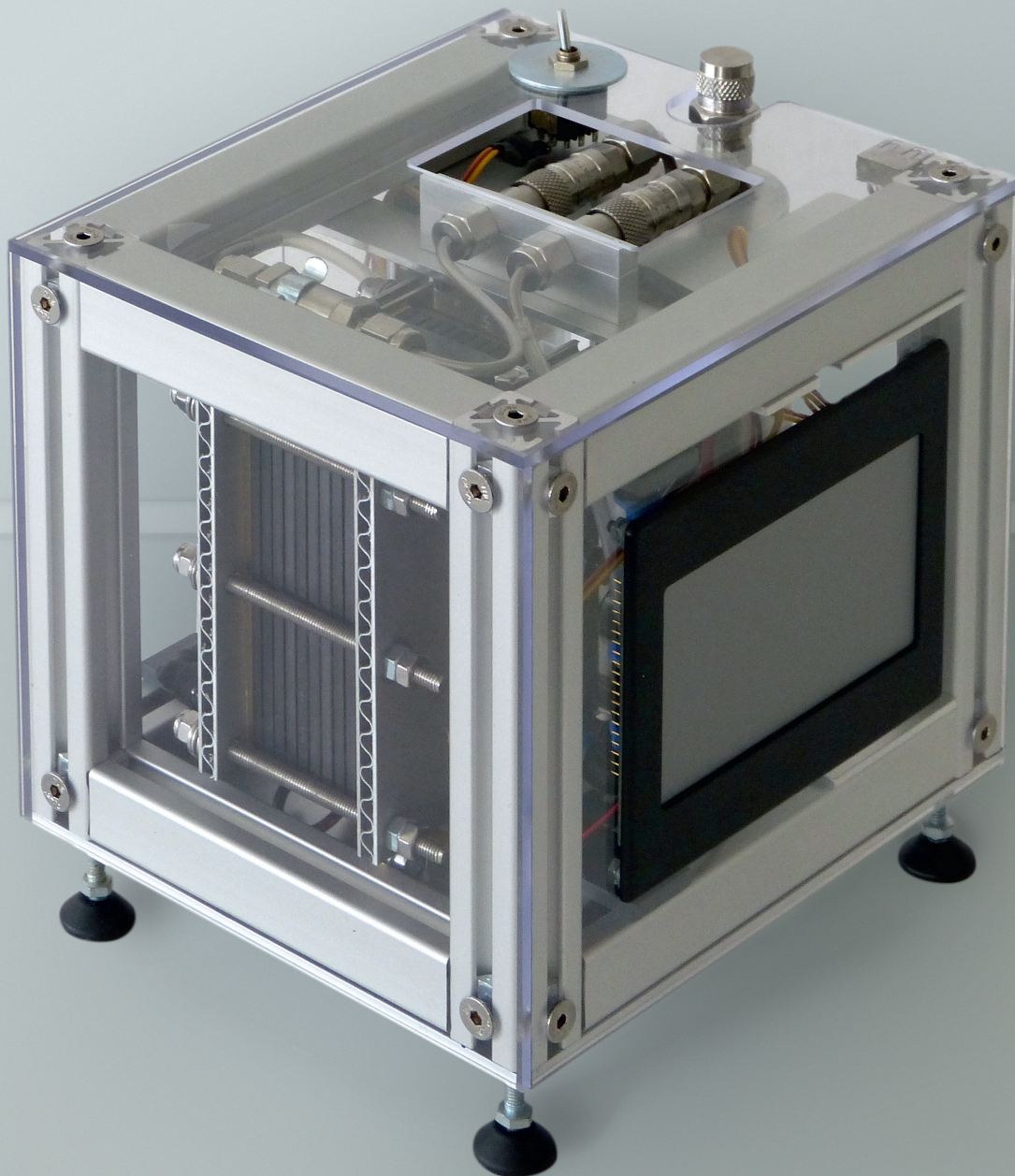

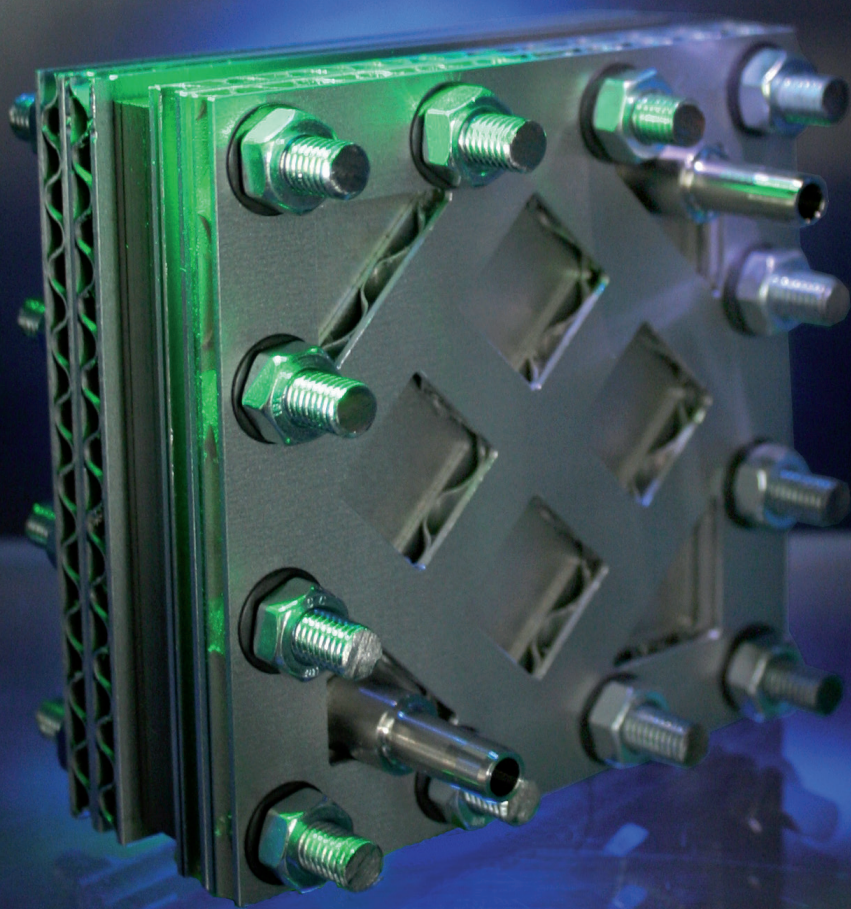

PARTNER FOR RESEARCH, SERVICE PROVIDER FOR INDUSTRY.

Are you interested in fuel cells or water electrolysis and looking for a competent partner for consultancy services, development and research?

The research group for fuel cells at Fraunhofer ICT offers support in all areas of polymer electrolyte membrane energy conversion technology. Benefit from the institute's expertise and international network. From materials to finished systems, we support you in the development of your idea from the concept up to market introduction.

Would you like to develop or optimize components?

Whether you are interested in fuel cells or water electrolyzer technology, our competence in the development and characterization of materials and components makes us a valuable partner. Catalysts, supports and the fabrication of membrane-electrode assemblies are the core aspects of our work. However, we also carry out the qualification of bipolar plates and sealing gaskets.

Are you interested in the construction of systems?

Through our comprehensive experience in the development and production of components, subsequent characterization and assembly as well as the integration of complete systems, we are an ideal partner for you and your project.

Are you planning to integrate a fuel cell or water electrolyzer into your product?

On our test stands we can evaluate operation points and strategies, in order to design an optimal system. Depending on your requirements we can also draw on the competences of other departments at Fraunhofer ICT, such as the Polymer Engineering Department for material development and the Energetic Systems Department for the safety assessment.

Alkaline direct alcohol fuel cell stack for portable applications. The endplates developed at the Fraunhofer ICT enable a weight reduction of about 30 % compared to usual cast aluminum end plates.

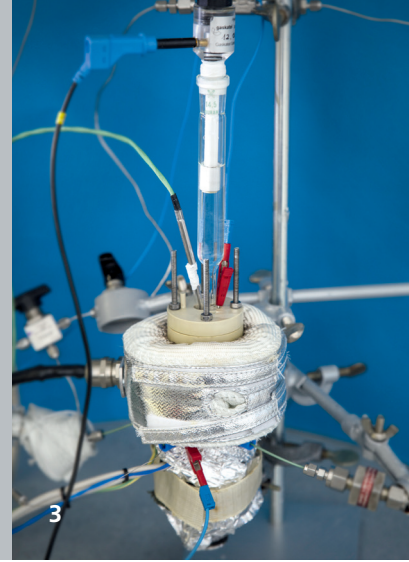
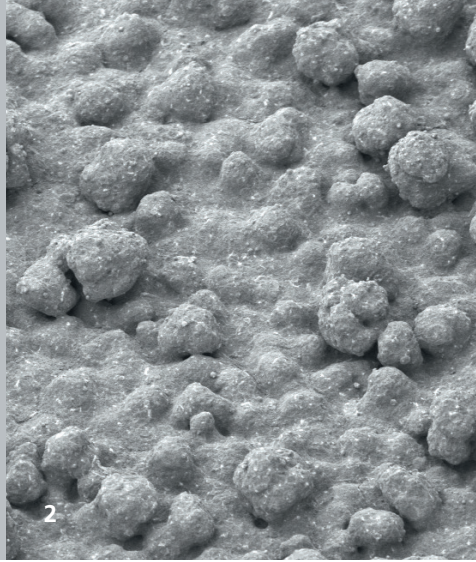

WATER ELECTROLYZER

Water electrolysis is the integral central system in the much-proposed hydrogen energy infrastructure. In the process water is split into hydrogen and oxygen by applying high potentials. Using water electrolysis renewable electricity (e.g. from solar cells or wind turbines) can be stored as hydrogen, contributing to flexible energy storage. Hydrogen can then be utilized for example in transport applications via fuel cells.

FUEL CELLS

Fuel cells are the most efficient tool for producing current from stored hydrogen. Here the operation is the reverse of the electrolysis. Fuel cells can however also be used with various other fuels, offering advantages like lower emission of noise and pollutants than combustion engines or higher energy storage densities than primary batteries.

- 1 *Electrochemical cell for the characterization of catalysts.*
- 2 *Scanning electrode microscopy of catalyst in an electrode layer.*
- 3 *HT-DEMS cell for the characterization of catalysts for HT-PEMFC under realistic conditions.*

Schematic diagrams of the working principle of fuel cells (a) and a simple system (b).

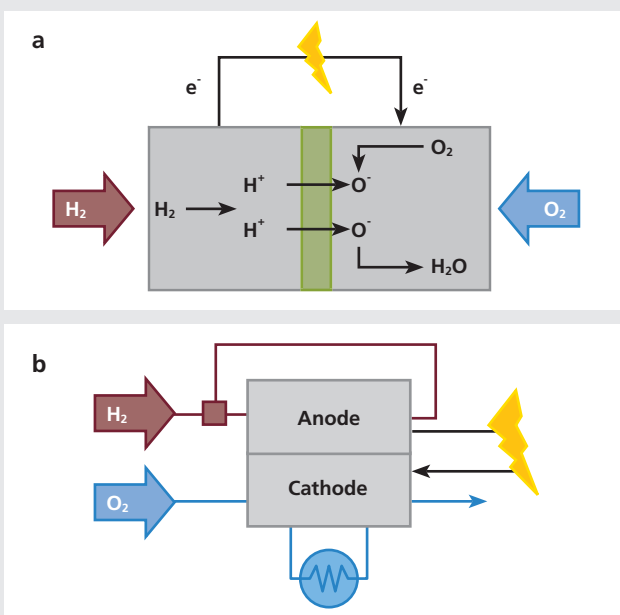

Schematic diagram of the proton exchange membrane water electrolysis cell.

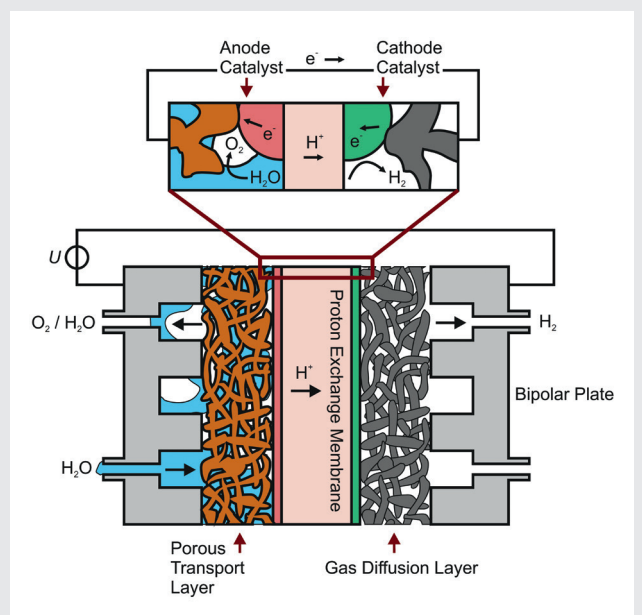

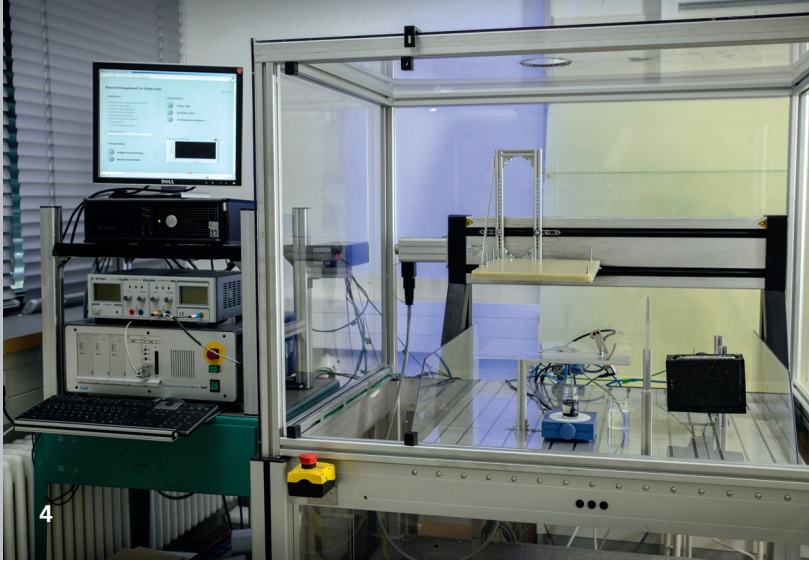

OUR OFFER

- Development and characterization of materials like catalysts, supports and binders
- Development, fabrication and evaluation of components like porous transport layers, gas diffusion layers and membranes
- Coating technology and manufacturing of membrane electrode assemblies
- Planning, construction and performance of conventional and unconventional measurements
- Evaluation of fuel cell stacks
- Conceptualization, assembly and integration of fuel cell systems

FACILITIES AND EQUIPMENT

Fraunhofer ICT has all the facilities and equipment necessary for research and development work:

- Fully-equipped electrochemical laboratories for the production and evaluation of fuel cells and electrolyzers
- Material investigation using EDX, microscopy and SEM/EDX
- Test set-ups with measuring equipment for the analysis of exhaust gases and for degradation experiments (DEMS, MS, GC, CV)
- Test stands for the evaluation of individual cells up to stacks and fuel cell systems
- Hardware in the loop testing of fuel cell systems and balance of plant components

MARKETS

The advantages of fuel cells, such as a high energy density, low emissions and high efficiency, mean that fuel cells have potential for many application areas.

- Portable energy supply
- Auxiliary power units for all types of vehicle
- Emergency energy supply
- Seasonal energy storage
- Energy supply for military vehicles and task forces

Proton exchange membrane water electrolysis similarly has many advantages like high gas purity, fast reaction to flexible load, high current densities and the possibility to generate hydrogen at relatively high pressure. Alkaline electrolysis systems on the other hand have much cheaper catalysts and are thus also under investigation at Fraunhofer ICT.

Fraunhofer ICT supports development in all application areas. Through our close cooperation with the German Armed Forces, we can also support you if you would like to produce your system for the military/defense market.

4 Facility for the automated spraying of membrane-electrode assemblies (MEAs).

5 Electric golf-caddy with fuel cell range extender module developed by Fraunhofer ICT.

PROJECT EXAMPLES

HyCon

In collaboration with partners from universities and other Fraunhofer institutes, a combined system of solar cell and water electrolysis was developed.

Objective

Development and optimization of the oxygen electrode for the water electrolysis cell.

Technology

Utilization of a catalyst support leads to increased active surface area and performance, while reducing critical raw materials and consequently costs.

Our offer

Synthesis and characterization of catalysts and supports. Coating technology and membrane-electrode-assembly manufacturing. Single cell tests and degradation analysis.



BePPel

In a joint undertaking, bringing together leading research centers in Germany, measurements of key parameters of bipolar plates, especially conductivity values, are defined and standardized.

Objective

Clearly defined measurement setups and procedures help the industry to evaluate raw materials and make it easier to compare different charges.

Technology

Understanding the influence of fabrication processes on the conductivity, contact resistance and current distribution is important in designing bipolar plate materials for energy conversion technology.

Our offer

Electrochemical corrosion measurements, measurement of in-plane and through-plane conductivity, design and construction of a special measurement setup and evaluation of in-plane current distribution in bipolar plate materials.

Supported by:



Coordinated by:



HT-Linked

Together with university partners and the catalyst development industry we are working on the improvement of electrodes for high-temperature fuel cells.

Objective

Improvement of the triple-phase boundary gas/electrode/electrolyte.

Technology

Improvement of the TPB is accomplished via three steps. First the dispersion of Pt nanoparticles on carbon support, second the chemical modification of the carbon support to improve phosphorous acid contact to the catalyst, and lastly the use of specially designed binders and coating methods to ensure a good connection of the electrode to the PBI membrane.

Our offer

Synthesis and characterization of oxygen reduction reaction catalysts. Chemical modification of carbon support and deposition of catalyst onto support. Long-term and degradation analysis of HT-FCs.

STHENIS

The project was part of the European Defense Agency Unmanned Ship (UMS) framework program. Together with the Bundeswehr Technical Center WTD 71 and the Norwegian FFI, a fuel cell was integrated into an unmanned marine vehicle.

Objective

Design of the peripherals of a fuel cell system for a 2.5 kW PEMFC commercial of the shelf (COTS) stack with a pure oxygen supply and operation at increased ambient pressure.

Technology

Optimizing cathode and anode supply systems to avoid water deposition in the stack and the necessity to purge. Selection of all balance of plant components with regard to space constraints. Safe operation with existing batteries without direct link to the battery management system.

Our offer

Characterization of the stack and determination of operating point. Planning and assembly of the system peripherals and subsequent implementation into an AUV and connection of the fuel cell and battery systems.

FUEL CELLS AND WATER ELECTROLYSIS
FROM THE MATERIAL TO THE FINISHED PRODUCT

**Fraunhofer Institute for
Chemical Technology ICT**

Joseph-von-Fraunhofer-Strasse 7
76327 Pfinztal (Berghausen)
Germany

Director:
Prof. Dr.-Ing. Peter Elsner

Contact

Dr. Jens Tübke
Phone +49 721 4640-343
Fax +49 721 4640-318
jens.tuebke@ict.fraunhofer.de

Dr. Carsten Cremers
Phone +49 721 4640-665
Fax +49 721 4640-800665
carsten.cremers@ict.fraunhofer.de

www.ict.fraunhofer.de